

# NÁVOD K INSTALACI / INSTALLATION INSTRUCTION

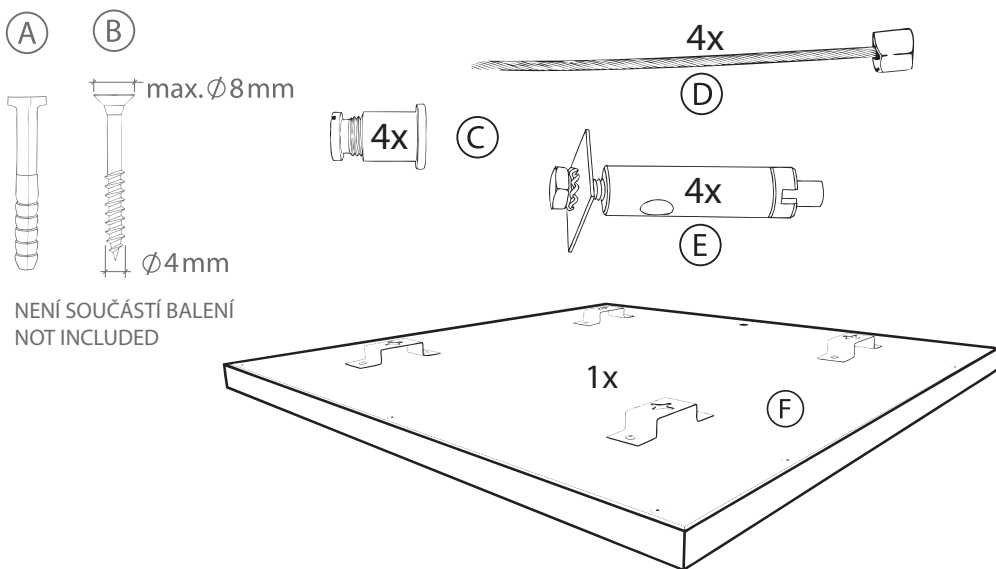

1.

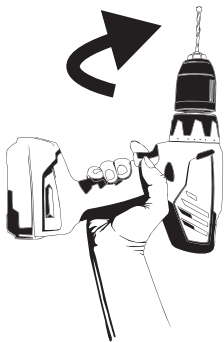

2.

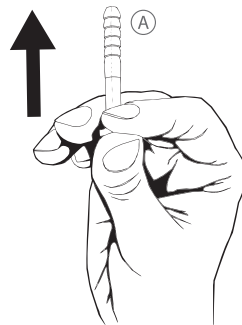

3.

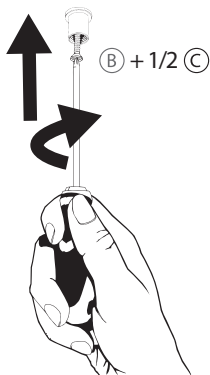

4.

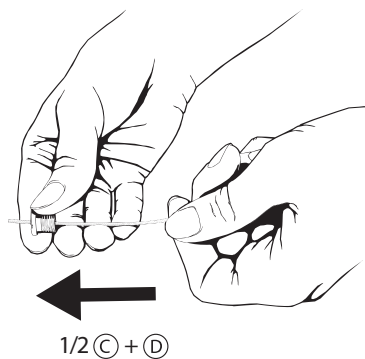

5.

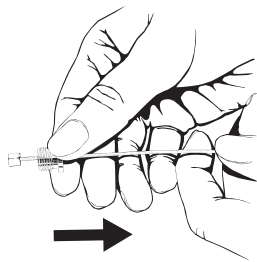

1/2 (C + D)

6.

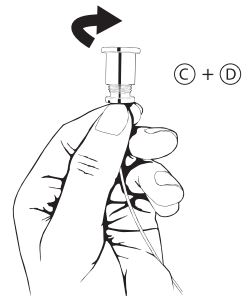

(C + D)

7.

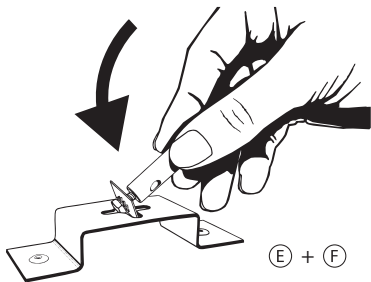

(E + F)

8.

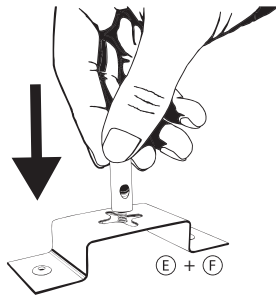

(E + F)

9.

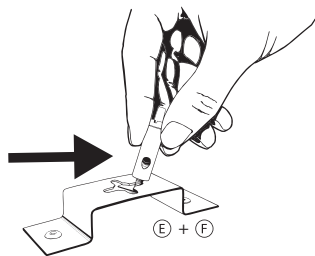

(E + F)

10.



(E + F)

11.

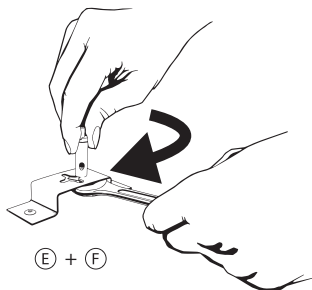

(E + F)

12.

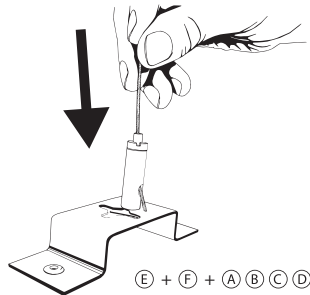

(E + F + A B C D)

13.

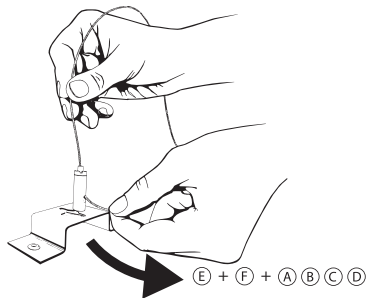

(E + F + A B C D)

14.

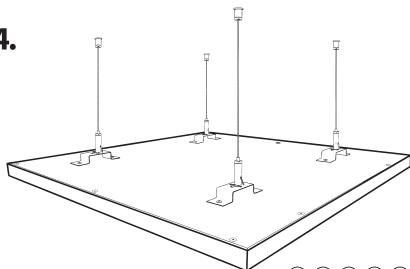

(A B C D E F)



**Fenix s.r.o.**

Jaroslava Ježka 1338/18a, 790 01 Jeseník  
tel.: +420 584 495 442, fax: +420 584 495 431  
e-mail: [fenix@fenixgroup.cz](mailto:fenix@fenixgroup.cz), <http://www.fenixgroup.cz>

**Fenix Trading s.r.o.**

Slezská 2, 790 01 Jeseník  
tel.: +420 584 495 304, fax: +420 584 495 303  
e-mail: [fenix@fenixgroup.cz](mailto:fenix@fenixgroup.cz), <http://www.fenixgroup.cz>